

X-Frame DR-2T

Dual detector system for Chest, General Radiography and Trauma



PRODUCT DATA

Product data

X-Frame DR-2T – Rev.4 (February 2011)

	Pag.
Description and Configurations	3
Technical Features	16
Digital Workstation	16
Generator – X-ray tube	18
TIETON Vertical Stand	19
BTE elevating table	19
TELESCOP Tube Stand	20
Size and Dimensions	21
Classifications	23
Installation and warranty	23

DESCRIPTION**X-FRAME DR-2T: DUAL DETECTOR DR SYSTEM FOR CHEST, TRAUMA AND GENERAL X-RAY APPLICATIONS**

ITALRAY DR SOLUTIONS is a complete range of digital radiography rooms and represents the perfect solution for modern Radiology Departments, for both General Radiography and Trauma. Thanks to the extreme modularity and full automation of the ITALRAY DR architecture, customers can rest assured that there is an ITALRAY DR system that perfectly fits all four main department needs:

CONNECTIVITY: use of Radiology Information Systems (RIS) and Picture Archiving and Communications Systems (PACS) for a full distribution of images and exam information throughout the Hospital

PRODUCTIVITY: optimization of department operating costs thanks to the high efficiency and examination speed of ITALRAY DR systems

DOSE REDUCTION: significant reduction of patient dose thanks to the Flat Panel Detector technology with extremely high sensitivity and dynamic range

IMAGE QUALITY: see details and anatomical structures with detail and contrast resolution levels unachievable with film or CR.

ITALRAY X-Frame DR-2T is a dual detector DR System, for Chest, Trauma and General X-ray Applications: from muscle-skeletal to chest and emergency examinations.

ITALRAY X-Frame DR-2T is composed by:

- ITALRAY **PIXEL HF** X-ray Generator
- ITALRAY **TIETON** multifunctional stand (for examinations in vertical position or on a mobile table) with Flat Panel Detector
- ITALRAY **BTE** a radiographic 4-way elevating table with Flat Panel Detector
- ITALRAY **TELESCOP** Synchro X-ray ceiling tube stand
- ITALRAY **X-FRAME DR** Digital Acquisition Workstation
- ITALRAY mobile table
- ITALRAY **X-Frame DR-M option:** ITALRAY X-Frame DR-2T system can be equipped with the innovative portable wireless Flat Panel Detector: the detector can be located in the vertical stand (TIETON) or in the table (BTE).

DIGITAL RADIOGRAPHY: UNSURPASSED IMAGE QUALITY

ITALRAY X-FRAME DR-2T is based on the Trixell solid state detectors, featuring amorphous Silicon (a-Si) technology and a Cesium Iodide (CsI) or Gadolinium scintillator: a combination that is the de facto standard in medical imaging and guarantees high quality X-ray images for immediate diagnosis, in real time and with low exposure. Images are acquired with a minimum pixel pitch thus producing brilliant images with an extremely sharp resolution matrix. Also, thanks to the 16 bits grayscale acquisition depth and the very-low-noise electronics, an incredible grayscale dynamic range is guaranteed, and even the most subtle details and the most diverse structures can be effectively identified in only one image, with image retakes practically eliminated.

With 43cm x 43cm and 41cmx43cm detectors, the largest active areas available on the market today, any anatomical district can be imaged, even in presence of tall/corpulent patients. Furthermore, ITALRAY **X-FRAME DR-M** option gives the possibility to use the Pixium PORTABLE 3543 in combination with either Pixium 4600 or Pixium 4143.

The Pixium PORTABLE 3543 is a lightweight and easy to handle digital flat-panel X-ray detector, that can be located both in the vertical stand (TIETON) and in the elevating table (BTE), providing DR systems with the needed freedom to capture difficult or unusual X-ray projections; furthermore it works in a wi-fi mode.



Combining its high detection quantum efficiency (DQE) with the large number of pixels (2372 x 3000) and high dynamic range (16 bits), the Pixium Portable is fundamental in revealing even the slightest anatomical detail for a high-precision diagnosis.

ITALRAY X-FRAME DR-2T does not have any special temperature/humidity requirement, and any standard modern Hospital room will be suitable for installation.

HIGH DQE, LOW DOSE

The Cesium Iodide (CsI) scintillator provides a very efficient X-ray absorption, which guarantees reduced patient dose, while fiber-optic-communication, between detector and workstation, provides diffusion-free high quality images. The Gadolinium scintillator is a proven and reliable technology for all-around applications.

For reporting purposes, the system can be equipped with a Dose Area Product (DAP) meter, and the measured dose is automatically stored into the image DICOM file header.

400kHz X-RAY GENERATOR OUTPUT FOR MAXIMUM IMAGE CLARITY

ITALRAY PIXEL HF X-ray generator is capable of a tube output frequency up to 400kHz. Thanks to this feature a very high X-ray beam quality is guaranteed at all load conditions. After all, image quality does start with a good X-ray source.

Furthermore, PIXEL HF automatically selects the most appropriate anode rotation speed (3.000 rpm or 9.000 rpm, with optional HSS) for the specifically selected load according to the chosen examination: by doing this, useless X-ray tube wear is avoided and X-ray tube life maximized.

AUTOMATICALLY DOWNLOAD WORKLIST PATIENT DATA FROM THE RIS

Thanks to the X-FRAME DR-2T seamless RIS worklist integration (Radiology Information System) the operator has all the necessary exam information (patient name, exam type, accession number, etc.) even before the patient walks in, and no time is wasted for data entering procedures, with all data-entering-related problems and errors virtually eliminated.

Also, when an exam is initiated without a worklist entry (e.g. trauma exam), the resulting study can be reconciled at a later moment with the appropriate RIS entry created for the new patient.

AUTOMATIC SINGLE PATIENT MULTI-EXAMINATION GROUPING

Oftentimes, when a single patient is scheduled to perform more than one examination, the RIS system will create multiple worklist entries, one for each examination. This can lead to workflow problems: as a matter of fact, in the typical fast-paced radiology department, it is easy for the operator to overlook the fact that the individual patient in the exam room has further examination scheduled and it can happen that the patient goes back to the dressing room and then home without having all the planned examinations performed.

To overcome this simple yet very common problem, X-FRAME DR-2T, when there is more than one examination scheduled for a single patient, groups all the examinations together, thus highlighting the multiple exams and ensuring that all the necessary images are taken and that nothing goes unchecked.

INTEGRATED OPERATOR CONSOLE WITH WIRELESS MICROPHONE(OPTIONAL)

ITALRAY X-FRAME DR-2T can be equipped with an integrated operator console with dedicated function buttons for the most common operations, integrated X-ray emission button, and wireless microphone to communicate with the patient in the room during the examination.



Integrated X-FRAME DR-2T operator console with wireless microphone.

INTUITIVE GRAPHICAL USER INTERFACE

The X-FRAME DR-2T Graphical User Interface (GUI) has been designed with operator needs in mind. The layout is simple and intuitive and the operator is guided step-by-step during all the image acquisition process and exam procedure. All relevant imaging and exam parameters are displayed on the screen and system status is verifiable at a glance.

Simple and intuitive, the X-FRAME DR-2T Graphical User Interface shows all relevant exam information and allows a fast and efficient operation.

INTEGRATED X-RAY GENERATOR CONSOLE

The PIXEL HF X-ray generator console is now integrated in the acquisition workstation. This allows a higher degree of integration between power generation and image acquisition, allowing the operator to focus his/her attention to only one system console, thus making his/her work easier and more efficient. And it also frees up precious desk space.

X-RAY PARAMETERS AND SYSTEM MECHANICAL POSITIONS AUTOMATICALLY SET ACCORDING TO THE EXAM TYPE

When the patient enters the exam room the entire system is already prepared to go: thanks to the direct interface with the ITALRAY PIXEL HF generator, all exam-specific and patient size-specific X-ray parameters are correctly predisposed, and acquisition parameters and curves are already appropriately set on the acquisition workstation. The operator can choose to work with the Automatic Exposure Control system or in manual technique, and this choice can be associated with each existing imaging protocol or incorporated into a newly created one. The system mechanical configuration is also verified to avoid wrong exposures.

EXAM-SPECIFIC AUTOMATIC COLLIMATION

According to the selected examination, patient size, and focal distance, exact collimation is automatically set thanks to the motorized collimator; and electronic collimation makes sure that only the significant portion of the image will be displayed. Manual collimation is obviously available if needed.

INNOVATIVE MOVING GRID WITH *INSTAFocus* PENDULUM MOVEMENT

X-FRAME DR-2T features the innovative *INSTAFocus* moving grid system which, thanks to the proprietary pendulum grid movement that keeps the grid always in optimal focusing conditions with minimum absorption, guarantees a dose reduction of up to 18% with respect to traditional moving grids. And the dose reduction is far greater when comparing to high-density stationary grids.

Moreover, thanks to the moving grid properties, there is no need to change the grid when moving from low SIDs (e.g. skull) to high SIDs (e.g. chest). Of course, the grid can always be removed if necessary for the specific exam (e.g. pediatric).

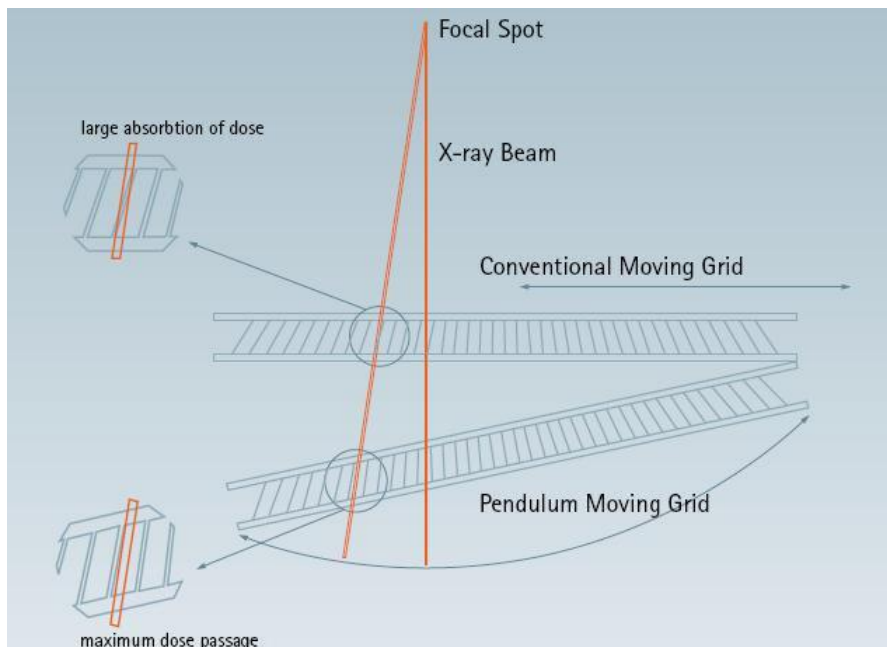

EXAM-SPECIFIC SOFTWARE PACKAGES AND 16-BIT IMAGE ARCHIVE

X-FRAME DR-2T is equipped with exam-specific software packages to perfectly fit each specific examination (chest, extremities, skull, etc.). So, whenever an individual exam type is selected, all detector acquisition parameters, pre-processing and post-processing image enhancement algorithms are automatically set to maximize image quality and diagnostic content. Moreover, images are stored with a gray level depth of 16 bit (65.536 levels of gray) thus guaranteeing maximum quality.

IMAGE AVAILABLE IN LESS THAN 5 SECONDS

Less than 5 seconds after exposure, the diagnostic image (and not just a preview) is already available for quality control purposes on the acquisition workstation monitor: this is extremely important for emergency/trauma applications where clinical decisions have to be taken right away and there is no time to waste.

PROPRIETARY HIERARCHIC *everest-X* IMAGE PROCESSING ENGINE

ITALRAY R&D Department has developed a proprietary image processing engine to further enhance the image diagnostic content. As a matter of fact, DR images, thanks to their very wide dynamic range, contain detailed information in both high-attenuation image areas (shoulders, abdomen) and low-attenuation image areas (lungs, cavities).

This information is contained in the image pixel data but without advanced processing the operator must work with Window/Level to extract the clinical content. This means that, even if all the information is available, it is impossible to observe high-attenuation and low-attenuation image areas at the same time since they correspond to different zones of the grayscale.

With *everest-X*, it is now possible to expand the latitude of a single image and see all the relevant clinical details at the same time and without time-consuming Window/Level adjustment. This is made possible by hierarchically dividing the original image into a number of sub-images which each represent different spatial frequency bands and then smartly process/combine these sub-images in order to enhance the clinical content and increase the image diagnostic value.

Of course, since each specific examination (e.g. chest, abdomen, extremities, etc.) needs a specific algorithm tuning, just like the X-ray generator parameters, *everest-X* parameters are automatically set once the exam type has been downloaded from the RIS in the worklist.

The name *everest-X* has been chosen because the final image sits on the top of a hierarchic subdivision of the original image which reminds of a very tall mountain!

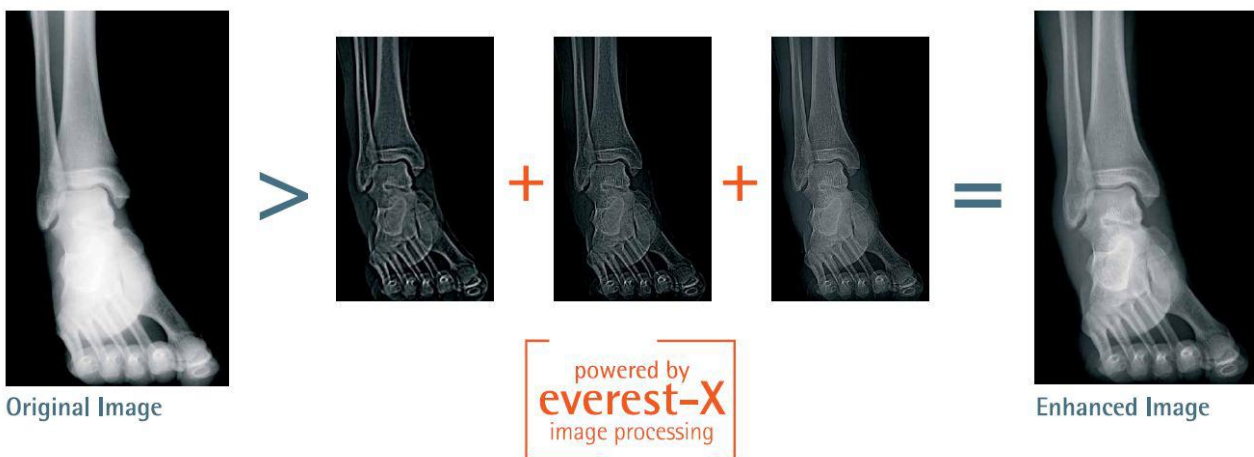

Sample operation of the *everest-X* algorithm with 3 sub-images shown.

NO MORE PATIENT RECALLS, NO MORE IMAGE RETAKES

With diagnostic images available in just 5 seconds, the operator can instantly verify if an image retake is necessary due to patient movement or other problems and the new image can be acquired instantly, without losing time in patient recalls.

Also, thanks to the extremely wide detector dynamic range and to the advanced exam-specific software packages, even in case of X-ray parameters problems, image quality is always at diagnostic level thus eliminating the need for image retakes. And let's not forget that this also means reduced patient dose.

FULL-SCREEN IMAGE DISPLAY

In order to make it easier to perform Quality Control or immediate Diagnosis (e.g. for trauma cases), the X-ray image is always displayed in full screen with all system controls and tools available in the background but with no image area covered by the Graphical User Interface. After all, with such an outstanding image quality it would be nonsense to display the image only in a small area on the display, surrounded by buttons and sliders.

MONOCHROME MEDICAL-GRADE LCD DISPLAY FOR MAXIMUM IMAGE CLARITY (OPTION)

On the acquisition workstation is available, as option, a monochrome medical-grade LCD monitor with high-brightness and providing maximum image clarity both for quality control and for diagnostic purposes (e.g. in emergency and trauma applications).

NO TIME WASTED IN MANUAL PROCESSING

Collectively, all the smart automatic configuration and setup processes make sure that most images show the desired clinical content immediately and require no time consuming post-processing. Based on our experience with the units already installed, over 95% of the images need no manual post-processing made by the operator, and the remaining 5% need only minimal post-processing.

POST PROCESSING TOOLS

The X-FRAME DR-2T acquisition workstation is equipped with a complete range of post processing tools, such as Edge Enhancement, Infinite and Real Size Zoom, Window/Level Adjustment, just to name a few. Furthermore, annotation and measurement tools are also available .

REDUNDANT HIGH-CAPACITY LOCAL IMAGE STORAGE

X FRAME DR-2T is equipped with a standard high-capacity local image archive, which is extremely important in case of momentary PACS unavailability or for stand-alone systems. The local archive can store up to 28.000 uncompressed 16-bit images or up to 56.000 compressed (lossless) 16-bit images. This is the equivalent of several weeks of work for the average installation.

Moreover, thanks to the redundant RAID1 mirroring configuration, images are stored at the same time on two separate parallel hard-drives, thus ensuring total data security.

PERFORM AN ENTIRE EXAM IN FEW MINUTES

A full X-ray examination can be completed in few minutes: the only bottleneck will be the patient undressing/dressing time. Published studies demonstrate that the productivity of a DR room is at least 3 times higher than a standard X-ray room!

DICOM INTEGRATION

Once the imaging session is completed, the entire study can be automatically sent to a PACS, a review workstation, or a DICOM printer; a large number of studies can be also maintained locally for temporary storage. And, most importantly, the intuitive Graphical User Interface makes the entire process smooth and easy. Needless to say, the X FRAME DR-2T DICOM layer has been thoroughly tested and will seamlessly interface with any DICOM environment.

STANDARD DICOM Part 14 CONFORMITY

X-Frame DR is **DICOM Part 14 (Greyscale Standard Display Function) standard compliant**, this means that whenever X-Frame DR monitors are calibrated in accordance to this standard (by means of dedicated and specific tool) , acquired images are perfectly the same if shown either on the acquisition workstation or on any other DICOM Part 14 compliant display system, as for example, review station or DICOM Printer.

DICOM PRINT COMPOSER WITH LIFESIZE PRINTING

Printing is made user friendly by the visual Print Composer that allows to arrange study images in an intuitive manner. Lifesize printing is also supported, for orthopedic applications.

SIGNIFICANT FILM AND CASSETTE-HANDLING SAVINGS

Furthermore, film-less operation allows major savings in terms of X-ray film and Printer film, not to mention the fact that bulky film developers are not needed anymore thus freeing up precious space and eliminating chemicals from the X-ray department.

Plus, since X-ray film handling (cassette preparation/handling, film development, film handling) is completely eliminated, with ITALRAY X-FRAME DR-2T operators can now dedicate their entire time and attention to the actual X-ray exam with a consequent much improved patient care and personnel optimization.

IMAGE STITCHING PACKAGE (OPTIONAL)

For full spine or full-extremity examination, X-FRAME DR-2T can be equipped with an optional stitching package which, thanks to the synchronized tube/detector movement, allows the operator to automatically take a number of adjacent images that are subsequently stitched together to provide a full-length image.

For patient safety and to grant for his immobilization during the stitching image acquisition, ITALRAY has equipped the X.-Frame DR-2T room with a specific accessory for dedicated examinations:

**GENERATOR-ONLY MODE**

For maximum uptime, X-FRAME DR-2T can always work with freestanding cassettes (film/CR) if necessary using the "Generator Only" option from the main GUI.

MAXIMUM PRODUCTIVITY: IN OTHER WORDS ITALRAY X-FRAME DR-2T

ITALRAY X-FRAME DR-2T DR room consists in: the **ITALRAY TIETON multifunctional vertical stand**, the **BTE elevating X-ray table**, the **ITALRAY TELESCOP Synchro tube stand** and XP mobile and elevating (optional) table.

X-FRAME DR-2T guarantees the high throughput and workflow efficiency of a Dual Detector General X-ray room and has been designed to be extremely intuitive to use. Therefore, X-Frame DR-2T guarantees optimal performances in all working conditions while providing maximum flexibility for all necessary applications.

TIETON MULTIFUNCTIONAL STAND OPERATION

The ITALRAY TIETON multifunctional stand has been conceived to be the ideal support for solid state DR X-ray detectors. Moreover, thanks to the multiple automatic motorized functionalities, all traditional exams can be performed with TIETON, from the standard stand-up chest to the trauma patient on a gurney.



X-FRAME DR-2T: exams for vertically-positioned patient.

AUTOMATIC MOTORIZED TUBE DETECTOR CENTERING AND COLLIMATION

Stand-up operation is extremely efficient thanks to the automatic motorized X-ray tube/detector centring which vastly improves the system throughput, and minimizes patient time in the X-ray room. Collimation is automatic motorized, according to the specific examination, patient size, and focal distance. Walk in, image, walk out, all in a few minutes and with no waste of time: that's what good patient care is also made of!

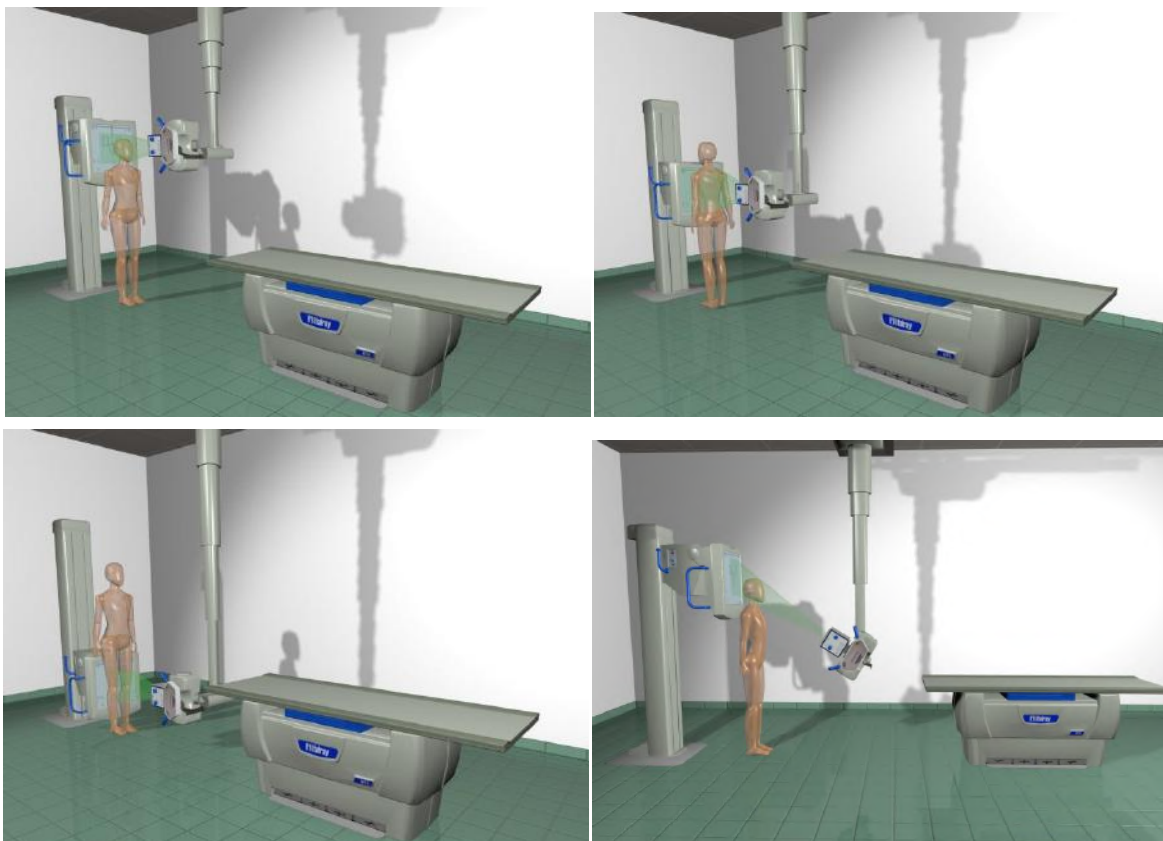

X-FRAME DR-2T: automatic motorized tube-detector centring and collimation..

AUTOMATIC MOTORIZED DETECTOR TILTING AND ROTATION

The DR detector support structure developed by ITALRAY for TIETON tilts between $+90^\circ$ and -20° with respect to the normal vertical position. This totally motorized movement is controlled via specific ergonomic controls and the detector inclination is shown in real-time by the display next to the controls. Moreover, when horizontal ($+90^\circ$) to image patients on a gurney or a table, the detector also rotates automatically by 90° . Therefore, thanks to this rotation, the grid is properly oriented for oblique projections and the ionization chamber is correctly positioned. Once the detector tilts, pre settled focal distance is automatically reached by the x-ray tube by means of motorized vertical movement.



X-FRAME DR-2T: automatic motorized tilting + rotation movement. For horizontal examinations.

AUTOMATIC COLLIMATOR LIGHT

Whenever the patient goes in front of the detector or the movable table is positioned over it, an intelligently positioned sensor engages and activates the automatic collimator light allowing for immediate collimation verification. The collimator light is also automatically activated whenever a new projection is selected on the acquisition workstation thus allowing for instant collimation size verification.



SPECIAL COLLIMATION FOR PAEDIATRIC PATIENTS

In case of chest examinations on paediatric patients, the collimation is aligned with the superior border of the detector and not centred on the detector centre. This is done because for chest examinations the patient always has to position himself/herself with his/her chin on the detector superior border, but with paediatric patients, only the superior portion of the detector is actually used, and if the collimation were to be centred on the detector centre, the patient would be exposed to unnecessary radiation.

WIDE IMAGING AREA FOR TRAUMA PATIENTS

ITALRAY TIETON is characterized by a wide column to detector centre distance that makes it possible to image all anatomical districts of patients on gurneys (e.g. right and left shoulders) without the need for any risky patient movement but just by briefly translating the gurney/table over the detector. Combined with the automatic horizontal/vertical, X-ray tube/detector synchronized servomovement and the automatic collimator light, these features make the ITALRAY TIETON particularly suitable for emergency applications where no time can be wasted and patient accessibility from any side is paramount.



X-FRAME DR-2T: extremely wide column to detector distance makes it possible to image all anatomical districts of patients on gurneys (e.g. right and left shoulders) without the need for any risky patient movement but just by briefly translating the gurney/table over the detector.

BTE ELEVATING TABLE OPERATION

For standard X-ray procedures, the BTE elevating table is available thus providing the operator a trusted and efficient system setup. And thanks to the very high level of system integration and to the multiple automatic functionalities, the overall workflow is optimized and productivity greatly enhanced.



AUTOMATIC TUBE-DETECTOR VERTICAL FOCAL DISTANCE

The BTE tabletop is typically lowered to its minimum height to facilitate patient access (especially important with elderly/disabled patients). The tabletop is then raised again for easier exam execution. While the tabletop is being raised, the X-ray tube automatically maintains the desired focal distance thus freeing the operator from having to adjust it and therefore maximizing productivity.

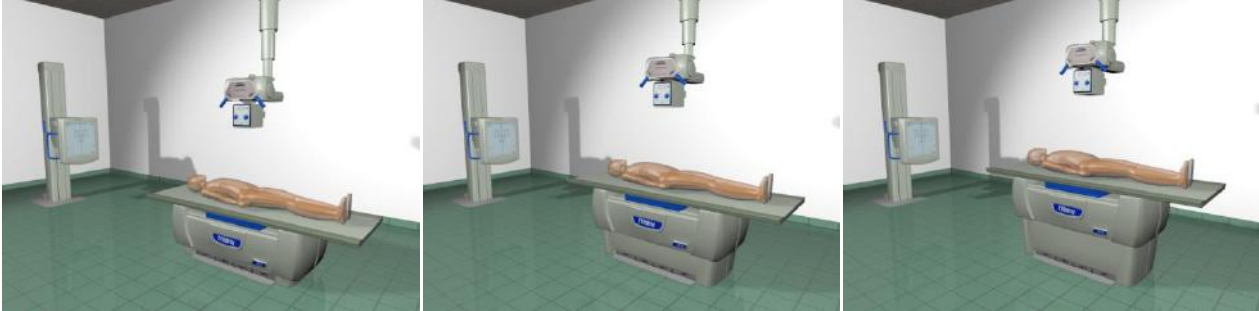

X-FRAME DR-2T: automatic focal distance.

AUTOMATIC TUBE-DETECTOR HORIZONTAL CENTERING AND COLLIMATION

When performing examinations on the BTE elevating table, the detector automatically follows the X-ray tube movements thus guaranteeing exact tube-detector centring also with oblique projections. Furthermore, the automatic motorized collimator adjusts the imaging area according to the chosen exam type.

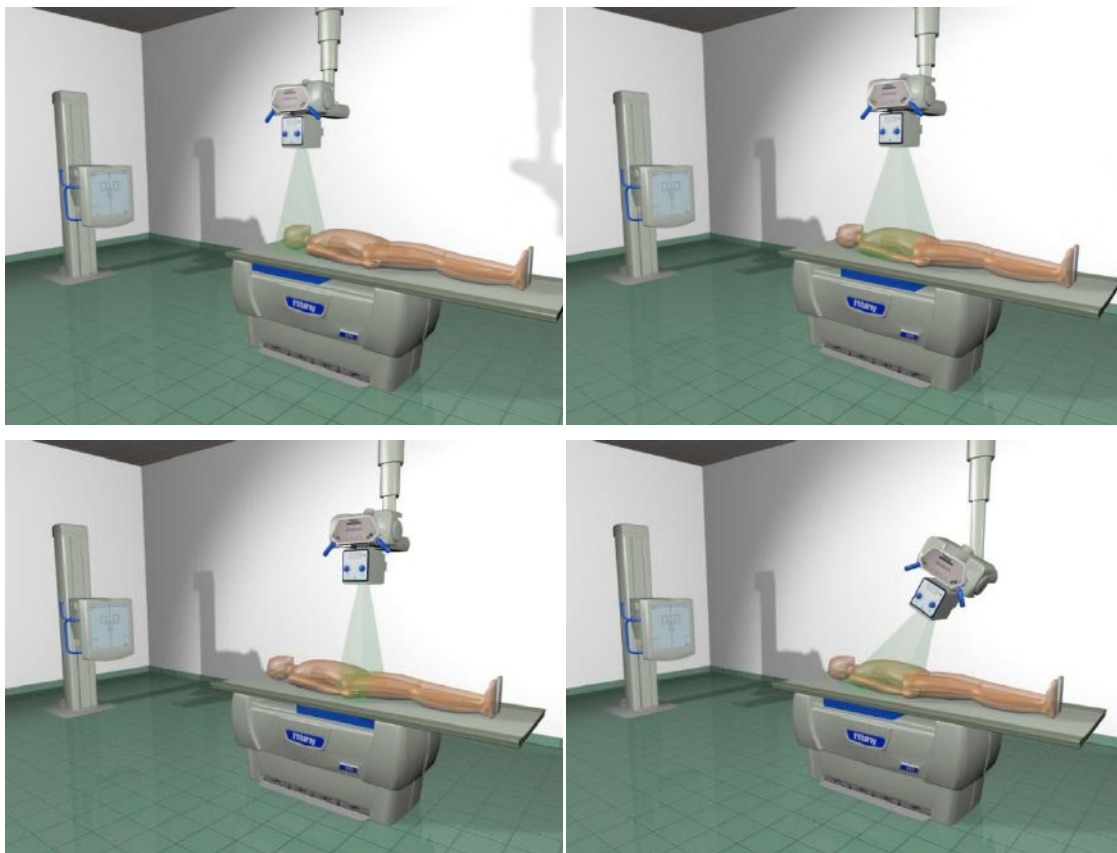

X-FRAME DR-2T: automatic centring and collimation.

FULL SYNCHRO OPTION

To reduce image acquisition time and to avoid useless patient repositioning, ITALRAY DR systems are characterized by high levels of automation, allowing the automatic and motorized collimation and system positioning all around the patient, basing on the examination to be performed.

With the optional FULL SYNCHRO package, all system movements are robotic and motorized with predefined working positions. The operator can therefore position the entire system for the selected projection by just pressing the corresponding button either on the remote console or on the tube stand console or on TIETION console. Furthermore all axes can be individually remote-controlled for fine positioning.



Optional FULL SYNCHRO: console with predefined working positions

COLLISION PREVENTION SYSTEM

Because safety is paramount, automatic system mechanical movements are instantly blocked when the safety proximity sensor detects that there is an obstruction in the movement direction or when the force sensors detect an obstacle. Only after the obstruction has been removed, can the system start moving again. Also, in order to make sure that everything is always under control, all movement have to be operator intentional.

REMOTE SERVICING

X-FRAME DR-2T is equipped with a remote servicing systems that allows ITALRAY service engineers to have access to the system via remote network for servicing or upgrading purposes. The remote servicing system availability is subordinate upon the technical/policy characteristics of the local Hospital network.

INVESTEMENT PROTECTION

With all these advanced features, investment protection has not been forgotten: if you have an ITALRAY DR-ready X-ray System in bucky version, the upgrade to DR is easy and seamless. And with the range of available tables and gurneys, there is a right solution for any need.

TECHNICAL FEATURES

ACQUISITION SYSTEM		
IMAGE ACQUISITION & STORAGE	Detector Make/Model	Trixell Pixium 4143
	Technology	Amorphous silicon
	Scintillator	Gadox ⁽²⁾ (standard), CsI ⁽¹⁾ (optional)
	Resolution, Acquisition	2775 x 2874x16
	Resolution, Processing	2775 x 2874x16
	Pixel pitch	148 µm
	Detector Dimensions	41x43 cm
	Detector Make/Model	Trixell Pixium 4600 (optional)
	Technology	Amorphous silicon
	Scintillator	CsI ⁽¹⁾
	Resolution, Acquisition	3001x3001x16 bit
	Resolution, Processing	3001x3001x16 bit
	Pixel pitch	143µm
	Detector Dimensions	43 x 43 cm
	Detector Make/Model	Trixell 3543p (option)
	Technology	Amorphous silicon
	Scintillator	CsI ⁽¹⁾
	Resolution, Acquisition	3000x2372x16 bit
	Resolution, Processing	3001x2372x16 bit
	Pixel pitch	144 µm
	Detector Dimensions	35x43 cm
	Max images locally archived	28000 images (no compression) 56000 images (lossless compression)
	Automatic LUT	YES, Linear and Logarithmic
	Image Enhancement	YES, Automatic <i>Everest -X</i>
	Anatomic Programs	YES, preconfigured and editable
	Image Flip/Mirror	YES
	R.O.I.	YES
Pan/Zoom	YES	
Window/Level	YES	
Automatic Window/Level	YES	
Edge Enhancement	YES	
Measurements, Annotations	YES	
Greyscale Inversion	YES	
Image Rotation	YES	
Electronic Collimators	YES	
Spatial Filters	YES	
Multi-Images Visualization	YES	
Stitching	YES, (optional)	
Grid control	YES, Automatic	
Grid type	Mobile <i>InstaFocus</i>	
UPS	YES	

⁽¹⁾Caesium Iodide

⁽²⁾Gadolinium

ACQUISITION SYSTEM		
DICOM 3.0	Print SCU	YES, with Print Composer
	Store SCU/SCP	YES
	Worklist Management SCU	YES
	Media Store SCU	YES, optional
	MPPS SCU	YES
	Storage Commitment SCU	YES
	Verification SCU/SCP	YES
	Query/Retrieve SCU	YES
Greyscale Standard Display Function		YES

WORKSTATION			
WORKSTATION	Processor	Intel	
	Hard disks *	System hard disk: 160 GB Hard disk for image archive: 500 GB Mirror disk for recovery: 500 GB	
	Network*	Gigabit Ethernet	
	SO	Windows XP Pro (embedded)	
	Microphone with patient	YES, wire-less integrated (optional)	
	* Minimum granted requirements		
WORKSTATION DIMENSIONS	Length	550 mm	
	Width	600 mm	
	Height	660 mm	
	Weight	95 kg	
DISPLAY	Type	TFT LCD high contrast and brightness	
	Dimensions	19,1"	
	Medical	YES; colour (standard)	YES; b/w (option)
	Contrast	2000:1	600:1
	Brightness	300 cd/m ²	700 cd/m ²
	Resolution	suggested 1280 x 1024	suggested 1280 x 1024

X-ray GENERATOR (*)	
Generator type	High frequency with output up to 400 kHz
Power supply	400-480 Vac +/- 10%, 3 Ø + N
Line frequency	50/60 Hz
Output power	50 kW – 65 kW - 80 KW
kV range	40 - 150 kV. Precision: 1kV
mA range	16-630 mA (50 kW)– 16-800 mA (65 kW) – 16-1000 mA (80 kW). Precision: 11 (50 kW)/12(65 kW)/13 (80 kW) pre configured values
Range mAs	0,1 - 1000 mAs
Time range	0,001 - 6,3 s. Precision: 39 pre configured values
Minimum mAs	0,5 mAs
HSS device	YES (optional)
Dose Meter	YES
AEC	YES
APR	More than 1000 anatomic programs. 3 points technique, 2 points technique, 1 point technique
Independent Operation	YES (X-ray Generator can also work independently with other imaging supports i.e. film and/or CR)
Generator Console	Integrated in the Acquisition Workstation (additional console optional)
Cabinet Dimensions (LxWxH)	55,9 cm x 40,6 cm x 123,7 cm
Generator cabinet weight	107 kg

X-RAY TUBE (*)	
X-ray tube type	Rotating anode
Focal spots	2: 06x0,6 mm (P _{max} =40 kW) e 1,2x1,2 mm (P _{max} =100 kW)
Anode speed	3000 and 10.000 routes/min
Maximum voltage	150kV
Anode heat capacity	400 kHU (600 kHU optional)
Anode heat dissipation	2465 HU/s
Housing heat dissipation	18 kHU/min
Inherent filtration	1,1 mm Al @ 75 kV
Dose Area Product Meter (DAP)	YES, with dose information stored in image DICOM header (optional)

(*) These data are provided only as indicative values and are referred to standard configurations. Any specific requirement can be differently satisfied choosing devices more suitable to meet customer needs.

TIETON MULTIFUNCTIONAL STAND	
Column height	2195 mm
Max Detector Centre Height (Vert. Pos.)	1690 mm
Min Detector Centre Height (Vert. Pos.)	440 mm
Min Detector Centre Height (Horiz. Pos.)	660 mm
Vertical Movement	Manual Counterbalanced and Motorized
Detector Tilting Range	- 20° to + 90°
Detector Tilting Movement	Automatic and motorized (with automatic stops at 0°)
Detector Horiz. Rotation	90° CW or CCW (factory selected)
Detector Horiz. Rotation Movement	Automatic and motorized
Detector Centre to Column Distance (Horiz. Pos.)	555 mm
Collision Detection	Proximity sensor
Weight	250 kg
Detector cover Al eq.	< 0,75 mm Al eq.

BTE ELEVATING TABLE	
Tabletop dimensions	2200 x 770 mm
Tabletop longitudinal travel	+/- 500 mm
Tabletop transversal travel	+/- 130 mm
Tabletop surface-Detector distance	68 mm
Detector longitudinal travel	400 mm – Motorized
Tabletop height	550 – 885 mm – Motorized
Maximum patient weight for full performances	200 kg
Weight	250 kg
Tabletop Al eq.	< 0,85 mm Al (< 0,5 mm Al with optional carbon-fibre tabletop)

TELESCOP SYNCHRO X-RAY TUBE SUSPENSION	
Longitudinal rails	4400 mm (longer/shorter length optional)
Longitudinal travel	3500 mm (longer/shorter length optional)
Longitudinal Movement	Manual (automatic and motorized movement optional)
Transversal rails	3000 mm (longer/shorter length optional)
Transversal travel	2180 mm (longer/shorter length optional)
Transversal Movement	Manual (automatic and motorized movement optional)
Brake type (L, T)	Electromagnetic
Vertical travel	1500 mm (1000, 1200, and 1800 mm optional)
Vertical Movement	Motorized with automatic detector centring
Brake type (V)	Permanent Magnet
Horizontal Axis Tube Rotation Angle	+120°/-200° (mechanical stops every 90° - automatic and motorized movement optional)
Vertical Axis Tube Rotation Angle	+200°/-135° (mechanical stops every 90° - automatic and motorized movement optional)
Brakes (Rotation)	Permanent Magnet
Collimator	Automatic Motorized (controlled by the acquisition workstation) with Automatic Light
Laser Collimation	Optional
Console	Handgrip with Ergonomic controls
Console Display	LCD. Display: SID (both with vertical stand and elevating table) x-ray tube rotation angle and error messages
Total weight	325 kg

POWER SUPPLY	
X-ray generator	380 Vac +/- 10%, 50/60 Hz (Optional 220Vac)
System	230 Vac +/- 10%, 50/60 Hz (Optional 110Vac)

ENVIRONMENT CONDITIONS	
Temperature	+10° / +40° C
Humidity	20% - 75% N.C.

SIZE AND DIMENSIONS

TIETON

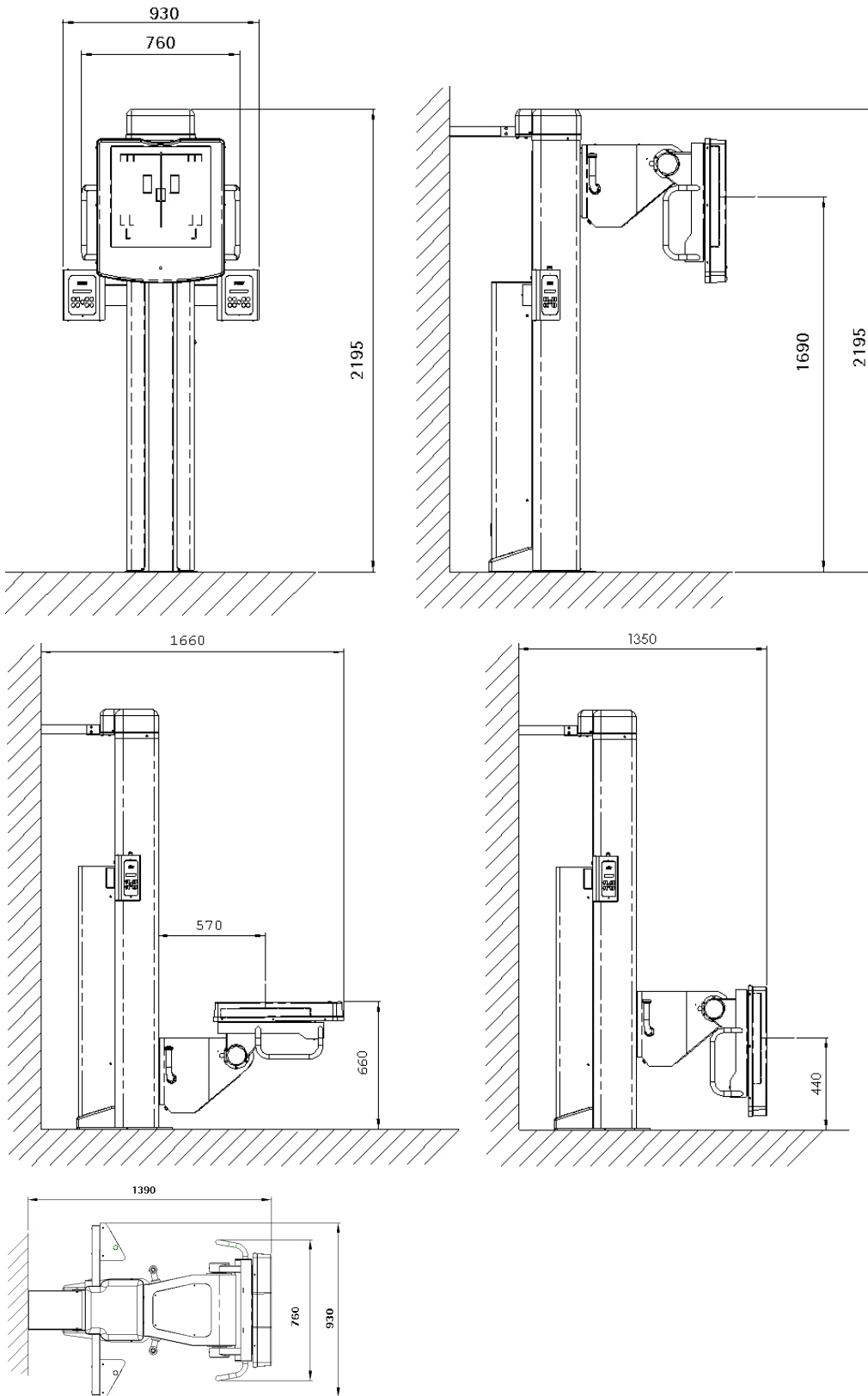

BTE

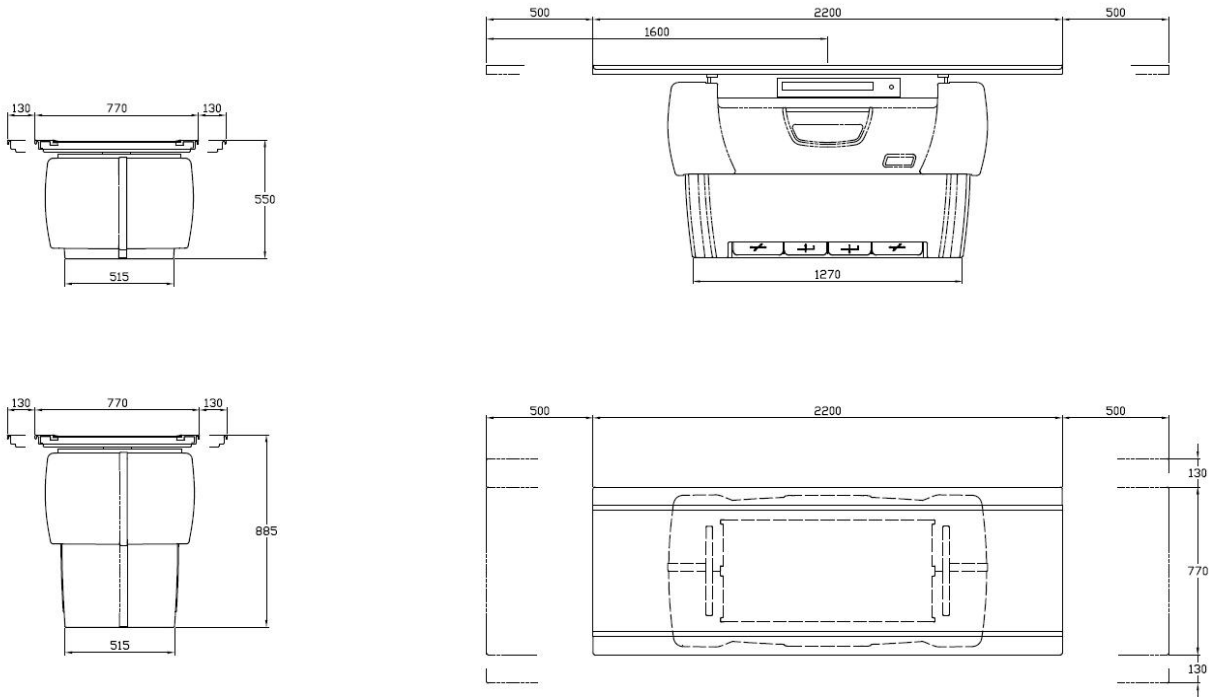

TELESCOP

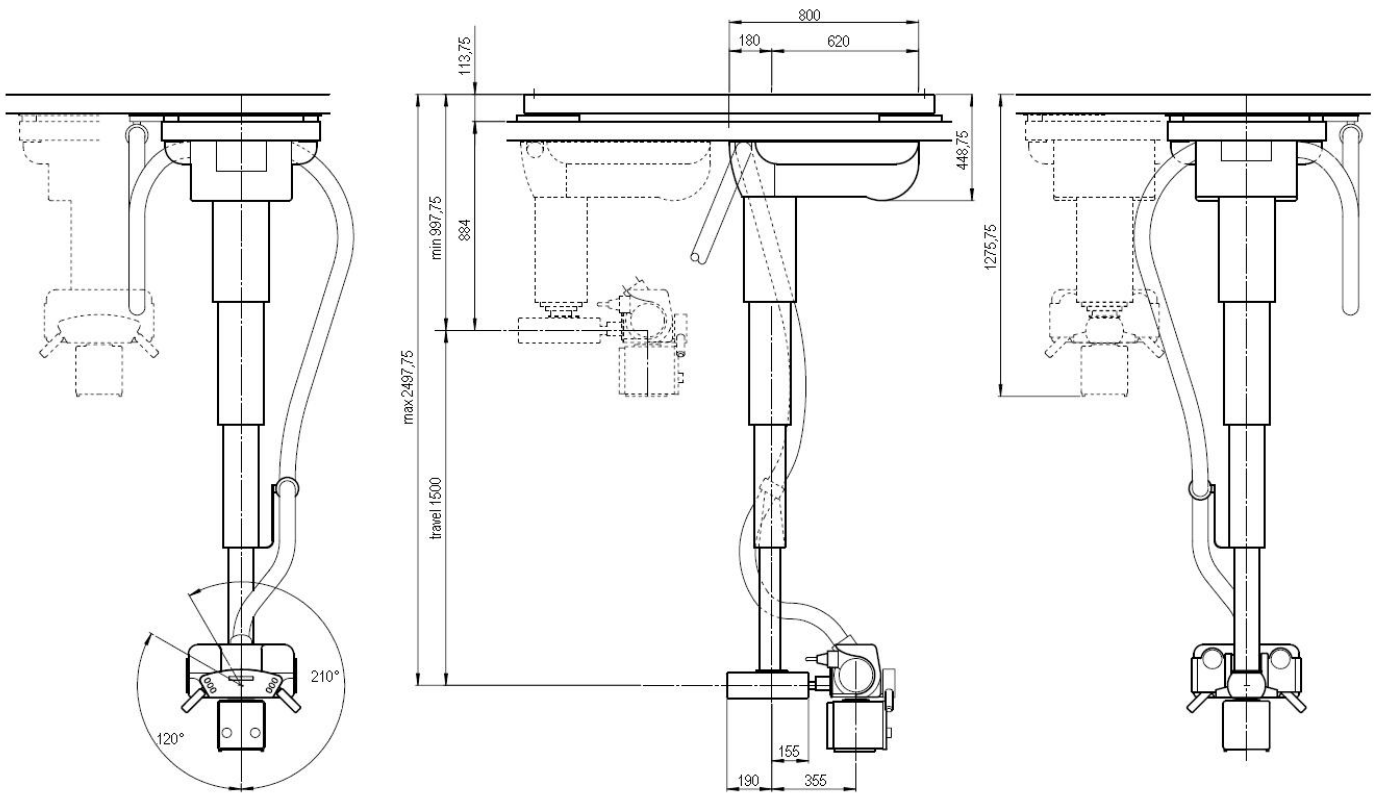

CLASSIFICATIONS

According to European Directive 93/42 CEE X-FRAME DR-2T is a class **II b** device. X-FRAME DR-2T has been developed in compliance with the UNI EN ISO 9001:2000 and UNI EN ISO 13485:2004. Moreover, X-FRAME DR-2T complies with the following Technical Norms: CEI EN 60601-series.

INSTALLATION AND WARRANTY

X-FRAME DR-2T can be installed only by authorized technical personnel that has been appropriately trained by ITALRAY. Upon request, ITALRAY Installation Office can prepare system installation layouts (including eventual construction/electrical).

ITALRAY guarantees its products for 1 (one) year from the delivery date. ITALRAY can offer to its customers a wide range of service plans that will perfectly fit all needs and preferences.

ITALRAY DR Systems are equipped with a **remote service system** that allows ITALRAY service engineers to have access the system via remote network for servicing and upgrading purposes. The remote servicing system availability is subordinate upon the technical/policy characteristics of the local Hospital network.

ITALRAY reserves the right to make modifications without any prior notice.



Via Del Parlamento Europeo 9/D 50018 Scandicci Firenze
tel. +39/055/7228511 fax. +39/055/7228512

website: www.italray.it e-mail: info@italray.it